

PUC 2530 Pole 300 cm silver

Article number (SKU)
Colour

7225304
Silver

Key Benefits

- Cable management
- Modular

The PUC 2530 is a 300 cm pole and is a part of the modular Connect-it system with which you can create a ceiling solution for medium- to large-sized displays.

The PUC 2530 is equipped with a multiple cable inlay system with which you can quickly and simply ensure that all cables are hidden. The pole is made of aluminium and, therefore, it can be easily cut at the required length. The Connect-it poles can be customized by the user. By inserting the plastic cover strips into the Connect-it pole or by replacing them by differently coloured strips, it can be customized to the house style of the customer. Multiple displays can easily be installed back-to-back, on top of each other or next to each other. Combine this pole with one of the Connect-it ceiling plates, Connect-it interface bar and Connect-it interface display strips for a complete ceiling solution.

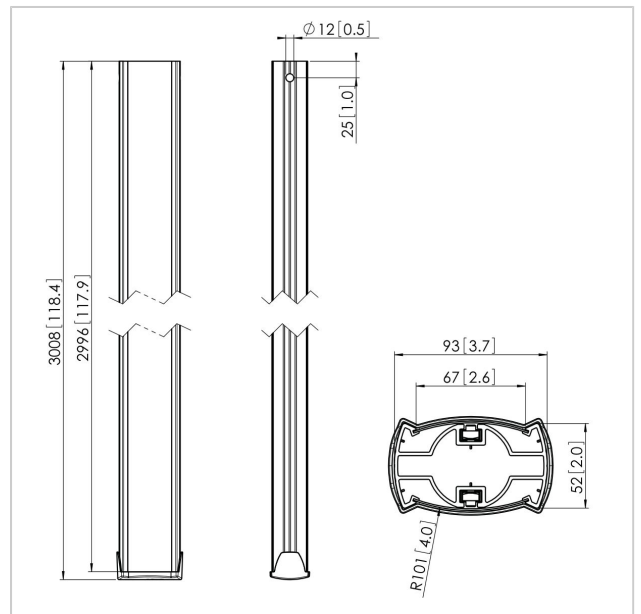

PUC 2530 Pole 300 cm silver

www.vogels.com



VOGEL'S HOLDING BV 2019 (c) All rights reserved.
Subject to printing errors, technical and price amendments.
Date:2019-05-10

Specifications

Product type number	PUC 2530
Article number (SKU)	7225304
Colour	Silver
EAN single box	8712285318740
Length	3000
TÜV certified	Yes
Guarantee	5 years
Max. weight load (kg)	80
Back-to-back displays	True
Connect It exceptions	2x if inches gte 65

